

CL

Forno elettrico modulare per pizzeria, pasticceria e panetteria

Modular electric oven for pizza, pastry and bread



CL CLASSIC - LCB I/R

CARATTERISTICHE TECNICHE

- 1 - 2 - 3 camere di cottura interamente in materiale refrattario con piano di cottura e cielo ad alte prestazioni e resistenza
- Resistenze corazzate "hy-pe" in acciaio inossidabile integrate nel refrattario del piano di cottura e del cielo
- Pannello di controllo digitale
- Controllo delle potenze del piano di cottura e del cielo separate
- Isolamento termico
- Massima temperatura di cottura 450 °C
- Valvola regolabile per scarico vapori
- Sportello con finestra in vetro temperato
- Sportelli frontali controbilanciati
- Lampade alogene ad alta resistenza e capacità luminosa
- Disponibile in acciaio inossidabile o in stile rustico (I/R)

ACCESSORI

- Cella di lievitazione ermetica
- Supporto del forno
- Modulo cappa

OPTIONAL

- Vaporiera (assorbimento massimo 1,4 Kw)
- Kit abbattimento vapori e odori con filtro ai carboni attivi (assorbimento massimo 0,7 Kw)
- 4 ruote (h = 16 cm + 2 cm per la cella di lievitazione)
- Piedi per celle di lievitazione (h min = 8 cm / max = 20 cm)

VERSIONI

- Disponibile in versione **CL "STAND" - LSB I/R** con 1 - 2 - 3 camere di cottura in acciaio alluminato con piano cottura in refrattario
- Piano di cottura e cielo con resistenze corazzate in acciaio inox

TECHNICAL SPECIFICATIONS

- 1 - 2 - 3 cooking chambers in full refractory material with high resisting and performing baking floor and ceiling
- Stainless steel armoured heating elements "hy-pe" integrated in the refractory floor and ceiling
- Digital control panel
- Top and bottom separate power control
- Thermal insulation
- Max cook temp 450 °C
- Adjustable steam exhaust valve
- Single tempered glazed door
- Counter balanced door
- High resistance and efficiency halogen lamps
- Available in stainless steel or rustic style (I/R)

ACCESSORIES

- Hermetic prover
- Oven support
- Hood module

OPTIONALS

- Steam injection system (max. absorption 1,4 Kw)
- Steam and odours damper kit for hood with active carbon filter (max. absorption 0,7 Kw)
- 4 wheels (h = 16 cm + 2 cm for the prover)
- Feet for provers (h min = 8 cm / max = 20 cm)

VERSIONS

- Available in **CL "STAND" - LSB I/R** version with 1 - 2 - 3 cooking chambers in aluminium coated steel plate with refractory cooking floor
- Top and bottom stainless steel armoured heating elements

1 CAMERA + SUPPORTO ALTO
1 DECK + HIGH STAND

✓ ALLACCIO ELETTRICO
ELECTRIC CONNECTION

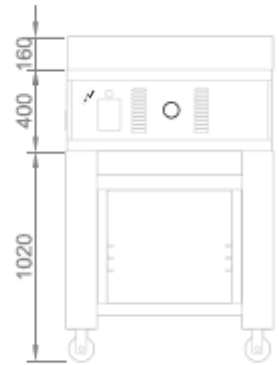
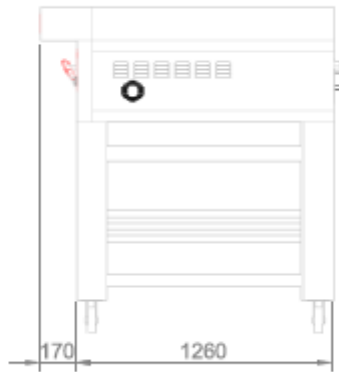
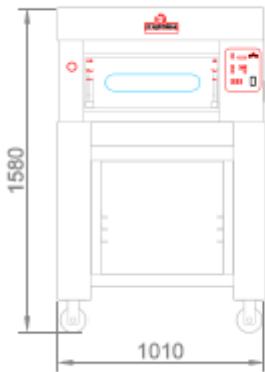

1 CAMERA + CELLA DI LIEVITAZIONE ALTA
1 DECK + HIGH PROVER

✓ ALLACCIO ELETTRICO
ELECTRIC CONNECTION

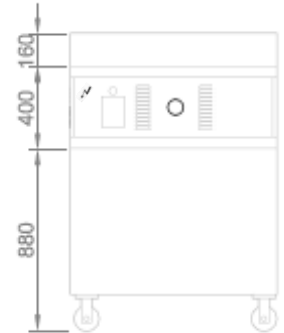
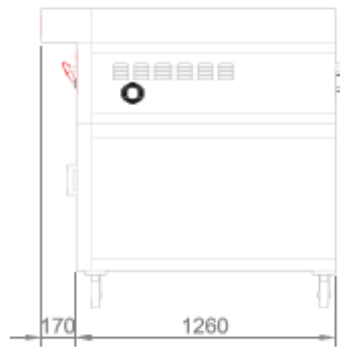
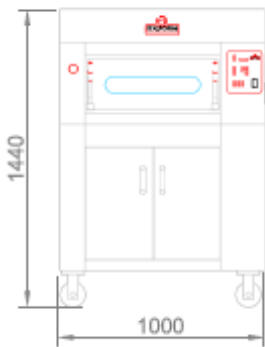

2 CAMERE + SUPPORTO ALTO
2 DECKS + HIGH STAND

✓ ALLACCIO ELETTRICO
ELECTRIC CONNECTION

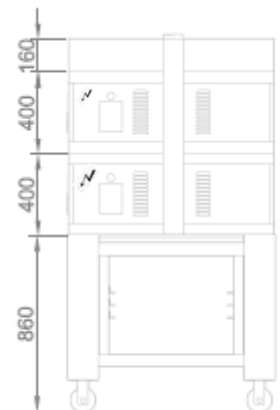
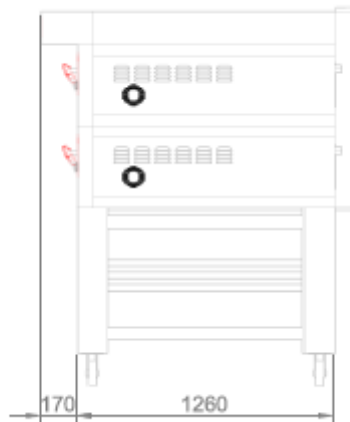
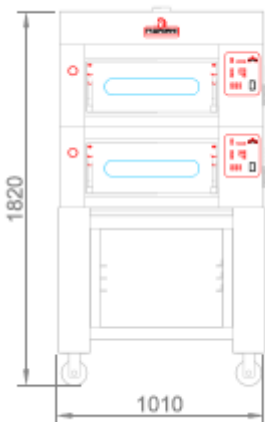

2 CAMERE + CELLA DI LIEVITAZIONE ALTA
2 DECKS + HIGH PROVER

✓ ALLACCIO ELETTRICO
 ELECTRIC CONNECTION

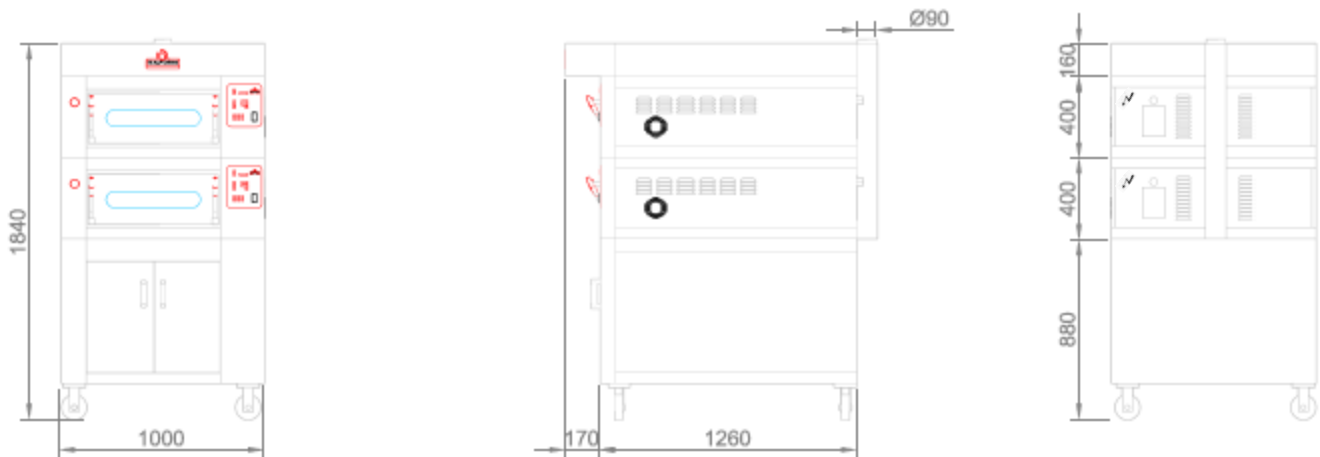

3 CAMERE + SUPPORTO BASSO
3 DECKS + LOW STAND

✓ ALLACCIO ELETTRICO
 ELECTRIC CONNECTION

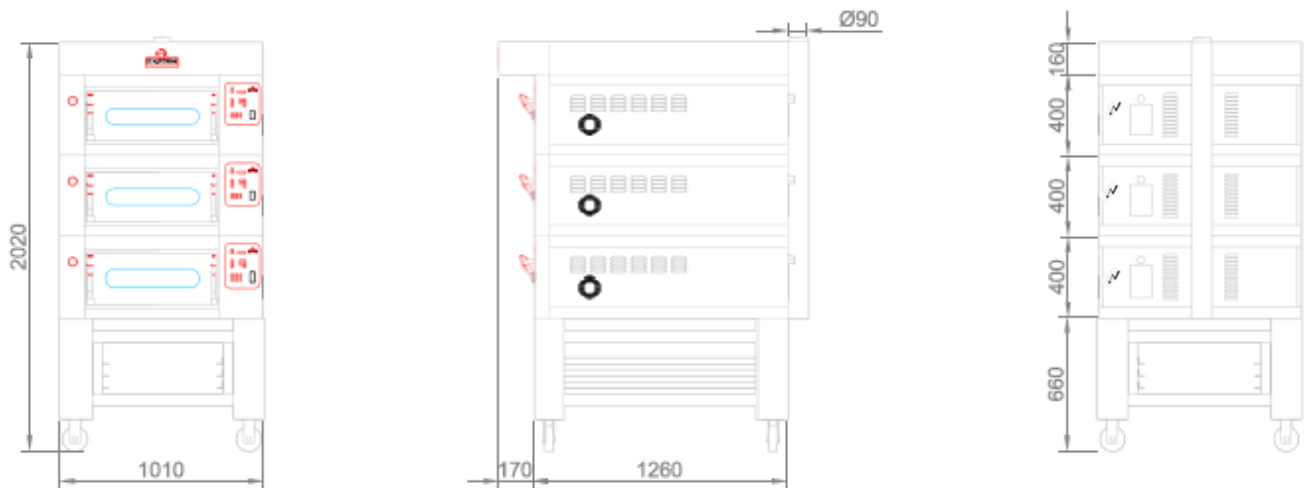

3 CAMERE + CELLA DI LIEVITAZIONE BASSA
3 DECKS + LOW PROVER

✓ ALLACCIO ELETTRICO
 ELECTRIC CONNECTION

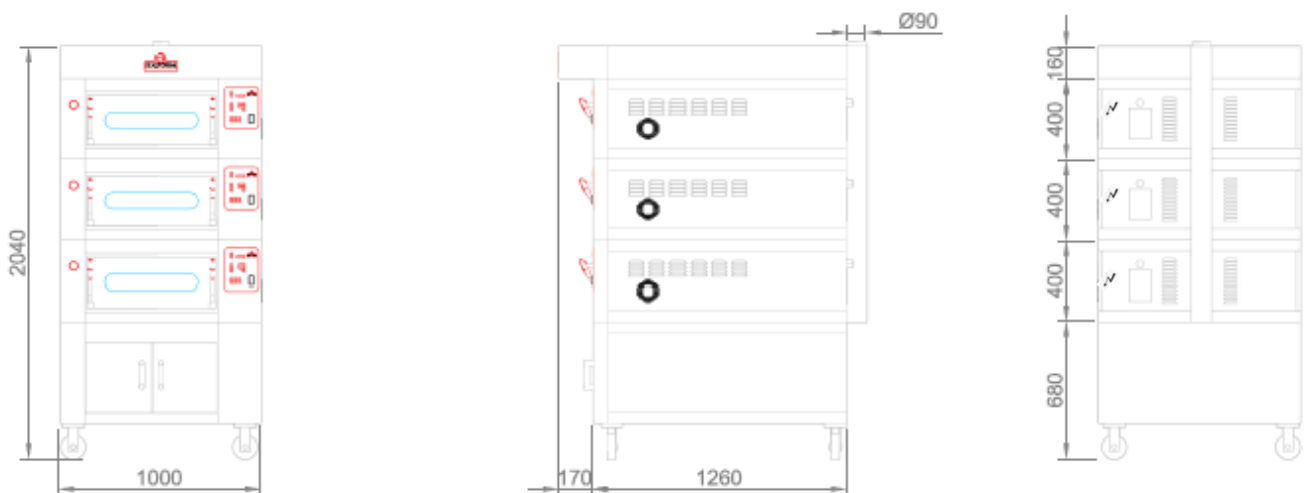

VALVOLA REGOLABILE PER SCARICO VAPORI ADJUSTABLE STEAM EXHAUST VALVE

Vista dall'alto 1 camera

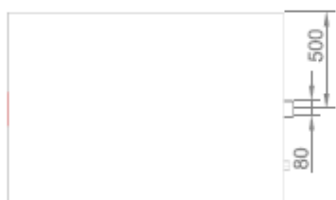

Vista dall'alto 2 o 3 camere

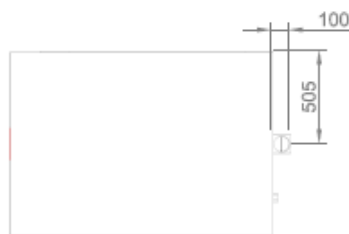

VAPORIERA STEAM INJECTION SYSTEM

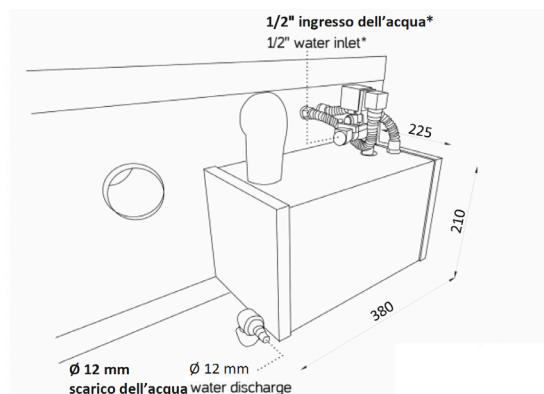

*Deve essere installato un riduttore di pressione massima di 0.5/0.6 bar
*0.5/0.6 bar max pressure reduce has to be installed
Assorbimento massimo 1,4 Kw
Max. absorption 1,4 Kw

CAPACITÀ DI CARICO PER CAMERA LOADING CAPACITY PER DECK

LCB I/R
LSB I/R

DIMENSIONI INTERNE
Internal dimensions
A/H 17 x L/W 60 x P/D 90 cm
6 Pizze Ø 30 cm
2 Teglie 60x40 cm
2 Baking pans 60x40 cm



DATI TECNICI TECHNICAL CHART



CL	Dimensioni interne (cm)			Dimensioni esterne (cm)			Peso	Alimentazione	Potenza	Potenza	Assorbimento	Temperatura	N° Teglie
	Internal dimensions (cm)			External dimensions (cm)			Weight	Supply	Power	Power	Absorption	Temperature	# Baking pans
	A/H	L/W	P/D	A/H	L/W	P/D	KG	V/Ph/Hz	KW	KW/h	Ampere	°C	60x40 cm
LCB / LSB I/R - DECK	17	60	90	40	100	126	175/145	400/3/50-60	7,2	4	11	0/450	
KCB / KSB - HOOD				16	100	143	30	230/1/50-60	0,3	0,3			
BCB / BSB - PROVER				70/50	100	126	80/65	230/1/50-60	1	0,5		0/90	14/6
SCBB / SCSB - STAND				86/70/50	101	126	49/44/37						16/6/6

*cappa isolante / Isolating Hood I = Frontale Acciaio Inox / Stainless Steel Fron R = Frontale rustico / Country Style Front